



GAS

PRO SERIES | RANGE MATCH

IMPERIAL



IRSB-36

SALAMANDER BROILER

- Infra-red burner with a protective screen.

PROFESSIONAL SALAMANDER BROILER

- 40,000 BTU Infra-red single control burner.
- Protective screen covers the burner.
- Spring balanced for easy maneuvering.
- 4 locking positions
- Rack assembly rolls out for easy access to cook.

EXTERIOR FEATURES

- All stainless steel exterior.
- Metal control knob for long life.
- Wall mount kits available as option.
- Reinforcement Channels



GAS

PRO SERIES | RANGE MATCH

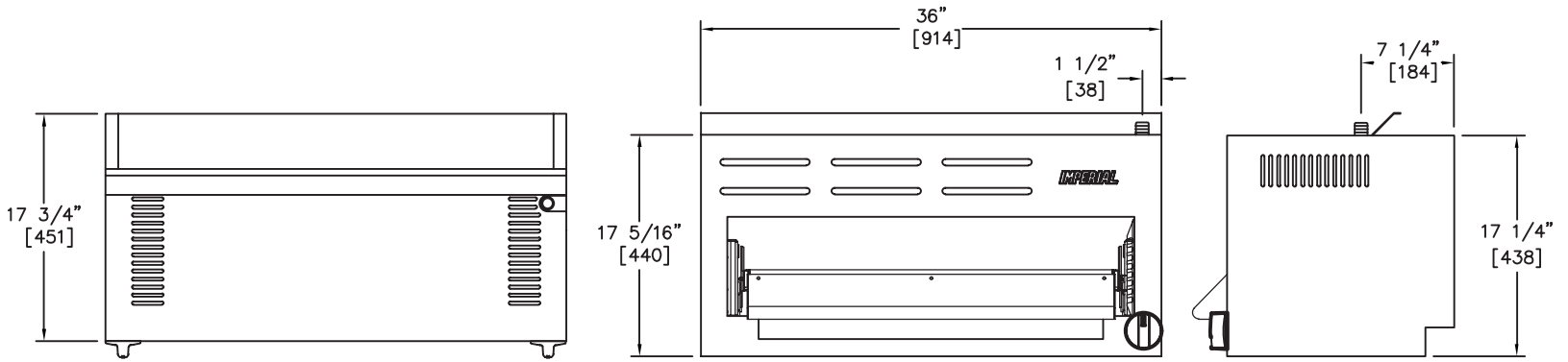

SALAMANDER BROILERS

MODEL	DESCRIPTION	GAS OUTPUT BTU	GAS OUTPUT KW	SHIP WEIGHT KG	SHIP WEIGHT LBS
IRSB-36	36" (914) INFRA-RED	40,000	10	95	210

MODEL	DIMENSIONS	CRATED DIMENSIONS
IRSB-36	36" W X 17-3/4" D X 19" H 915MM X 451MM X 483MM	38" W X 19-3/4" D X 21" H 965MM X 502MM X 508MM

SALAMANDER ACCESSORIES

- 2 ea. Reinforcement channels to mount the IRSB-36 on a range
- Wall mount bracket
- Counter top installation, leg kit
- One point 3/4" gas connection from IRSB to IR range. Specify IR Range model.
- Stainless Steel, top, bottom, front and sides for IRSB is standard.

