



DOMINA PRO 700 - NEUTRAL ELEMENTS

N74TC



TOP

TECHNICAL DATA:

External dimensions - WxDxH (cm) 40x73x25

Drawer

ADDITIONAL TECHNICAL DATA:

Weight (kg) 21

Volume (m3) 0,2

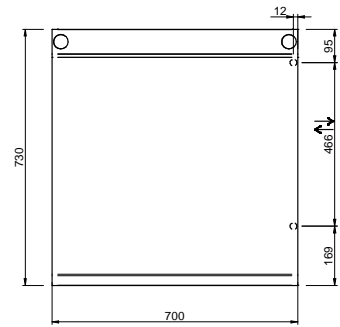
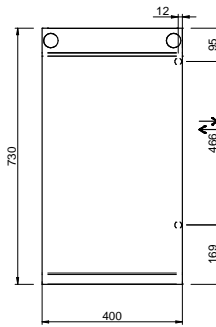
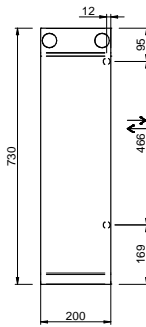
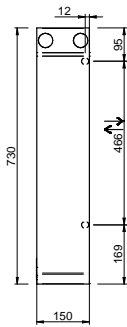
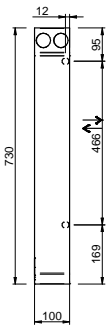
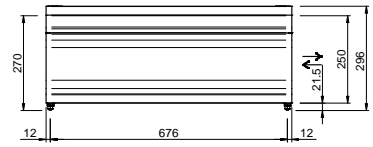
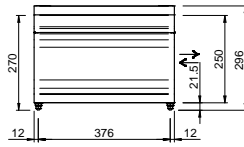
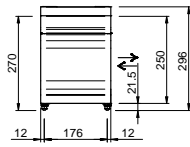
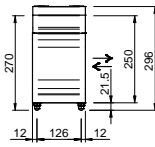
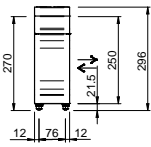

LEGENDA SIMBOLI / LEGEND



INGRESSO GAS / GAS INLET
(EN 10226-1) Ø M 1/2"



INGRESSO ACQUA /
WATER INLET Ø M 1/2"



ATTACCO EQUIPOTENZIALE /
EQUIPOTENTIAL



ALIMENTAZIONE ELETTRICA /
POWER SUPPLY



SCARICO ACQUA / OLII
WATER / OILS DRAIN



REGOLAZIONE PIEDINI /
FEET ADJUSTMENT (h 0/+50)
/ TOP VERSION (h 0/+5)