



DOMINA PRO 700 - NEUTRAL ELEMENTS

N71T



TOP

TECHNICAL DATA:

External dimensions - WxDxH (cm)	10x73x25
Drawer	<input type="checkbox"/>

ADDITIONAL TECHNICAL DATA:

Weight (kg)	5
Volume (m3)	0,02

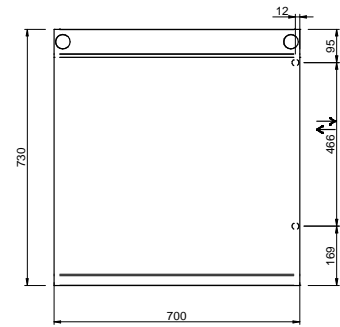
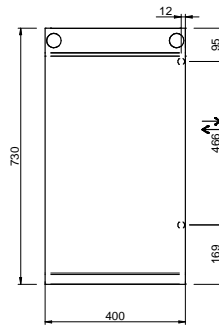
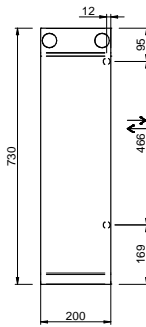
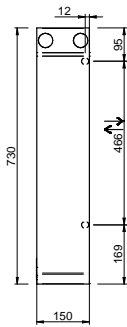
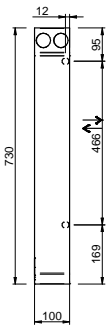
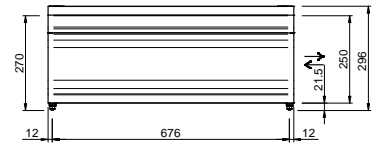
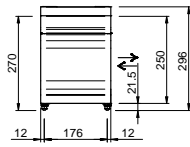
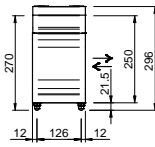
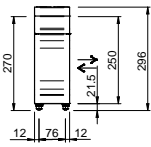

LEGENDA SIMBOLI / LEGEND



INGRESSO GAS / GAS INLET
(EN 10226-1) Ø M 1/2"



ALIMENTAZIONE ELETTRICA /
POWER SUPPLY



INGRESSO ACQUA /
WATER INLET Ø M 1/2"



SCARICO ACQUA / OLII
WATER / OILS DRAIN



ATTACCO EQUIPOTENZIALE /
EQUIPOTENTIAL



REGOLAZIONE PIEDINI /
FEET ADJUSTMENT (h 0/+50)
/ TOP VERSION (h 0/+5)