



DOMINA PRO 700 - NEUTRAL ELEMENTS

**N705T**

---



TOP

**TECHNICAL DATA:**

External dimensions - WxDxH (cm)	15x73x25
Drawer	<input type="checkbox"/>

**ADDITIONAL TECHNICAL DATA:**

Weight (kg)	7
Volume (m3)	0,03

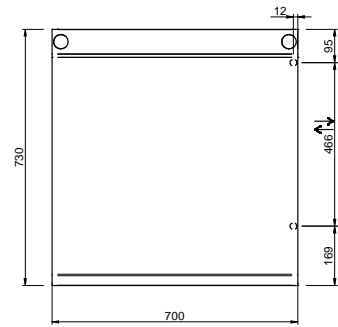
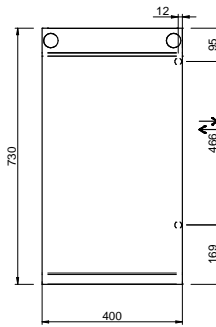
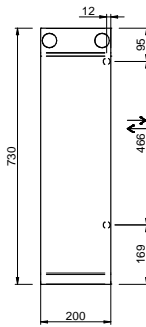
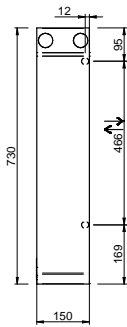
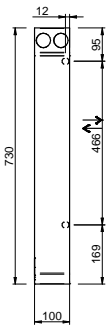
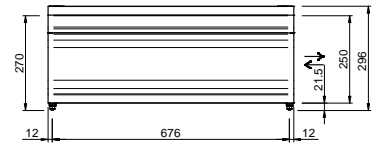
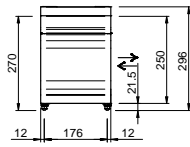
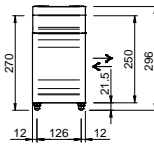
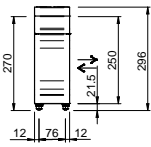

LEGENDA SIMBOLI / LEGEND



INGRESSO GAS / GAS INLET  
(EN 10226-1) Ø M 1/2"



INGRESSO ACQUA /  
WATER INLET Ø M 1/2"



ATTACCO EQUIPOTENZIALE /  
EQUIPOTENTIAL



ALIMENTAZIONE ELETTRICA /  
POWER SUPPLY



SCARICO ACQUA / OLII  
WATER / OILS DRAIN



REGOLAZIONE PIEDINI /  
FEET ADJUSTMENT (h 0/+50)  
/ TOP VERSION (h 0/+5)