



MAGISTRA PLUS 700 - GAS RANGES

## MFB74TXS



### 2 BURNERS TOP

#### TECHNICAL DATA:

External dimensions - WxDxH (cm)	40x71,4x25
Nr. Burners 5.5 kW	2
Total power (kW)	11

#### ADDITIONAL TECHNICAL DATA:

Weight (kg)	30
Volume (m3)	0,2

Flex Burners with brass burner caps and self-stabilizing flame, to cook safely and for simpler maintenance. Each burner has an adjustable power range, from a minimum of 1.5 kW to a maximum of 5.5 / 7 kW, to get maximum flexibility. The pilot flame is protected inside the main burner. The placement of the burners allows use of pans up to 40 cm in diameter. The single cast iron pan support are dishwasher-size. 1 mm worktop in AISI 18/10 stainless steel. Excellent alignment with joints.

Versions with oven:

Stainless steel cooking chamber with enameled bottom, stainless steel double-wall door with insulating casing.

Gas oven: 6 kW burner (8 kW for maxi oven) with self-stabilizing flame; thermostatic temperature control with safety valve and thermocouple; piezo-electric burner ignition. 3 GN 2/1 rack support.

Electric oven: 5.3 kW (2,6 kW for ventilated oven) stainless steel armoured heating elements placed on the bottom and on the top of the cooking chamber; thermostatic temperature control with separate bottom/top temperature control for maximum cooking flexibility. 3 GN 2/1 rack support (static oven) and 3 GN 1/1 rack support (ventilated oven).

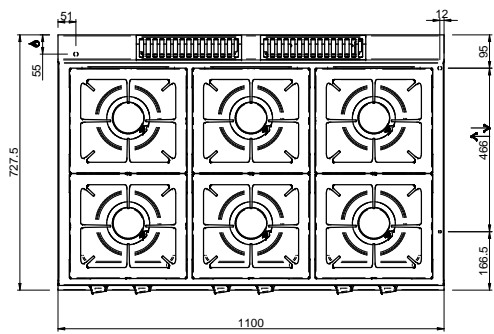
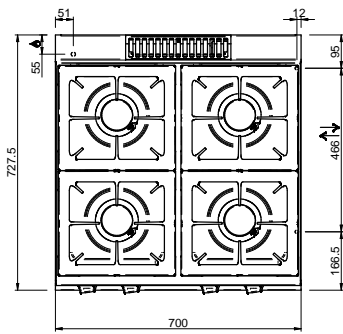
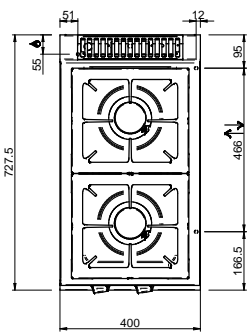
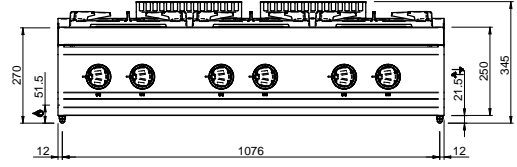
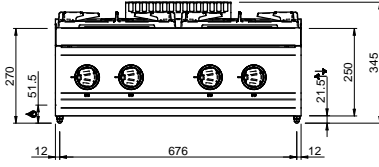
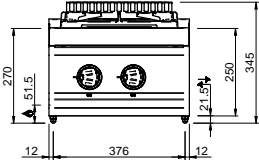

LEGENDA SIMBOLI / LEGEND



INGRESSO GAS / GAS INLET  
(EN 10226-1) Ø M 1/2"



INGRESSO ACQUA /  
WATER INLET Ø M 1/2"



ATTACCO EQUIPOTENZIALE /  
EQUIPOTENTIAL



ALIMENTAZIONE ELETTRICA /  
POWER SUPPLY



SCARICO ACQUA / OLII  
WATER / OILS DRAIN



REGOLAZIONE PIEDINI /  
FEET ADJUSTMENT (h 0/+50)  
/ TOP VERSION (h 0/+5)