



DOMINA PRO 700 - PASTA COOKERS

CPG74A



1 BOWL, GAS ON CLOSED STAND

TECHNICAL DATA:

External dimensions - WxDxH (cm)	40x73x85
Tank capacity (lt-GN)	26
Total power (kW)	8,5
IPX5	●

ADDITIONAL TECHNICAL DATA:

Tank dimensions - WxDxH (cm)	31x34x30
Supply (N)	230V 1N 50/60 Hz
Weight (kg)	50
Volume (m3)	0,5

The moulded tanks are in AISI 316 anti-corrosion stainless steel, with rounded corners for easy cleaning. The optional pasta baskets

are in AISI 304 18/10 stainless steel with thermal handle. Electric valve to load the water.

Gas versions: stainless steel burner with self-stabilizing flame. Thermocouple safety device connected to the pilot flame.

Piezo-electric burner ignition.

Electric versions: electric heating elements in armoured stainless steel; power adjustment with four position switch; control of the temperature with operating and safety thermostat.

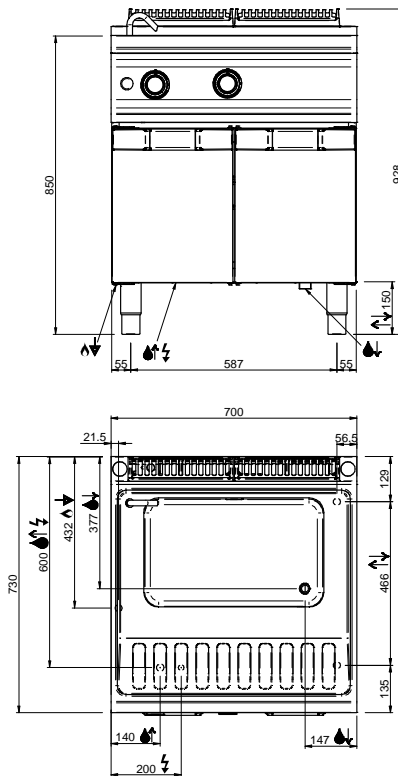
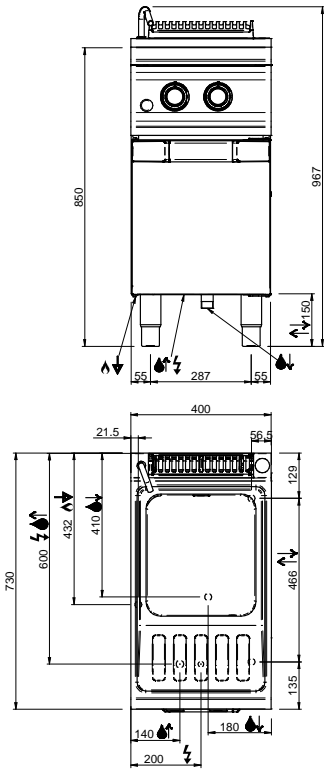

LEGENDA SIMBOLI / LEGEND



INGRESSO GAS / GAS INLET
(EN 10226-1) Ø M 1/2"



ALIMENTAZIONE ELETTRICA /
POWER SUPPLY



INGRESSO ACQUA /
WATER INLET Ø M 1/2"



SCARICO ACQUA / OLII
WATER / OILS DRAIN



ATTACCO EQUIPOTENZIALE /
EQUIPOTENTIAL



REGOLAZIONE PIEDINI /
FEET ADJUSTMENT (h 0/+50)
/ TOP VERSION (h 0/+5)