



P8P5 - Lincat Panther 800 Series Free-standing Hot Cupboard - Plain Top - W 1855 mm - 2.5 kW

Helping to cater in demanding environments such as cafeterias, canteens and restaurants, the Panther 800 Series Hot Cupboard is perfect for plating and garnishing and as a pass to front of house staff, while it also provides extra workspace or can be used as a mobile workstation.

- ✓ Helping to cater in demanding environments such as cafeterias, canteens and restaurants
- ✓ Fan assisted hot cupboard provides even heat distribution, fast heat up and recovery times, and lower energy usage. Four shelf positions allow adjustment to meet individual needs.
- ✓ Fully 1/1 GN compatible hot cupboard for operational efficiency. Units available to take 5 x 1/1 GN containers up to 150mm deep.
- ✓ Accurate digital electronic control of the hot cupboard temperature, adjustable between 20 and 99 °C, ensures compliance with food hygiene regulations
- ✓ Double skinned construction provides efficient heat retention and a cool to touch exterior - safe and energy efficient. Removable doors and shelves allow access to the fully stainless steel interior for easy cleaning
- ✓ Supplied with two heavy duty multi-section chrome plated rod shelves capable of taking the heaviest loads

Specifications

Summary		Power and Performance	
Brand	Lincat	Total Power kW	2.50
Range	Panther	Temperature Range °C	20-99
Series	800 Series	IP Rating	IP24
Power Type	Electric	Temperature Control	Electronic
Unit Type	Free-standing		
Available in UK Only	No		
UK Warranty	2 Years Parts and Labour Warranty		
Export Warranty	Contact your local dealer		
GTIN	5056105103592		

Key Specifications		Capacity	
Number of Shelves included	2	Plate Capacity	476
Number of Shelf Positions	4		
Heated Base	Yes		
Heated Gantry	No		
Static or Mobile	Mobile		

Weights and Dimensions		Supply Connections	
Unit Height (External) mm	900	Requires Installation	No
Unit Width (External) mm	1855	Requires Electrical Supply	Yes
Unit Depth (External) mm	850	UK 3 Pin Plug	Yes
Height (Internal) mm	432	Requires Hardwiring	No
Width (Internal) mm	1,670	Electrical Supply Rating Watts	2,500
Depth (Internal) mm	512	Single Phase Amps	10.9
Shelf Dimensions Width mm	1,610	Single Phase Voltage	230
Shelf Dimensions Depth mm	512		
Net Weight Kg	171		

Shipping

Packed Weight Kg	188.1
Packed Height cm	110
Packed Width cm	188
Packed Depth cm	90

Available Options

Overshelf or Gantry

PG5A	PG5A - Ambient Gantry
PG5H	PG5H - Heated Gantry
PS5A1	PS5A1 - 1 Ambient Overshelf
PS5A2	PS5A2 - 2 Ambient Overshelves
PS5A3	PS5A3 - 3 Ambient Overshelves
PS5H1	PS5H1 - 1 Heated Overshelf
PS5H2	PS5H2 - 2 Heated Overshelves
PS5H3	PS5H3 - 3 Heated Overshelves

Door Locks

PDL5	PDL5 - Lockable Door
-------------	----------------------

Corner Guards

PCG	PCG - Corner Guards [Set of Four]
------------	-----------------------------------

Trayslides

PTS5	PTS5 - Tray Slide
-------------	-------------------

Legs/Castors

PLK	PLK - Legs [non chargeable]
------------	-----------------------------

Available Accessories

PLK/S	PLK/S - LEG KIT [FOR CONVERSION IN THE FIELD]
PPB8	PPB8 - ADDITIONAL PUSHBAR

Technical Picture

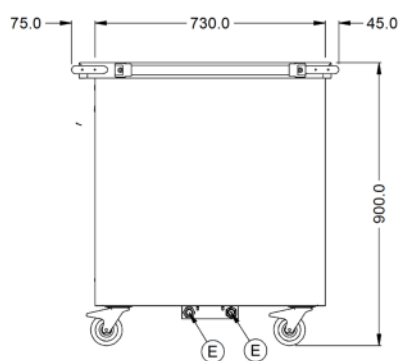
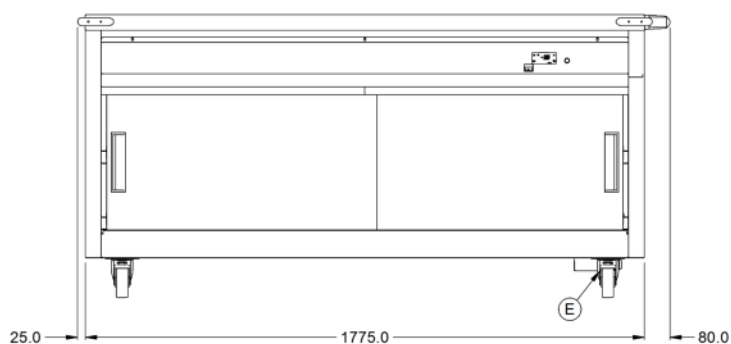

Lincat Limited

Whisby Road,
Lincoln, LN6 3QZ,
United Kingdom

Company No: 2175448

A member company of



Customer Care

Tel: +44 1522 875500
Email: care@lincat.co.uk

Export Customers

Tel: +44 1522 875536
Email: export@lincat.co.uk

Opening Hours

Monday – Friday:
8.30am – 5pm